

Safety instructions

Important! Before commencing installation work disconnect the main cable from the power supply - remove fuse or turn switch to "OFF"!

1. Installation should be carried out in accordance with the local safety regulations.
2. In order to prevent damage, please check walls for cables before drilling holes.
3. Please ensure that all electrical connections (even preassembled lamps) are screwed tightly or are fully inserted as good contact is essential for a long life-span at high currents. Please check for tight connections after changing or adjusting lamps. Screwed connections must be tightened after 20 minutes.
4. Please do not place objects on your system (e.g. for decorative purposes) if they were not delivered with the system.
5. The lamps get very hot when in use. Please allow lamps to cool down before touching.
6. Do not change lamps or spots when switched on.
7. System should not be enlarged with additional lamps.
8. Use of a dimmer is highly recommended. Dimmer must be compatible with type of bulb.
9. If the external flexible cable or cord of this luminaire is damaged, it shall be exclusively replaced by the manufacturer or his service agent or a similar qualified person in order to avoid a hazard.
10. The glass used for this lamp is hand-blown. Only 1st. quality has been chosen. Air bubbles and variations in thickness and colour is normal.
11. We reserve the right to make technical alterations.

Please keep these instructions.

Fitting: E27

2022-10-26 EU

Rizzato 301

Assembly Instructions

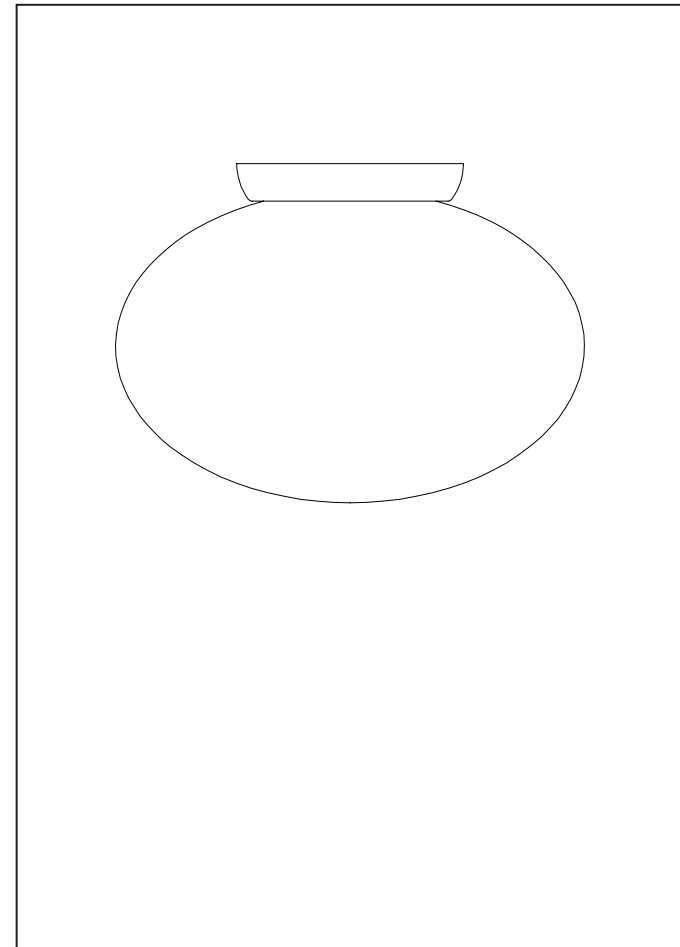

NUURA

www.nuura.com
info@nuura.com

© 2022 All rights reserved



NUURA

© 2022 All rights reserved

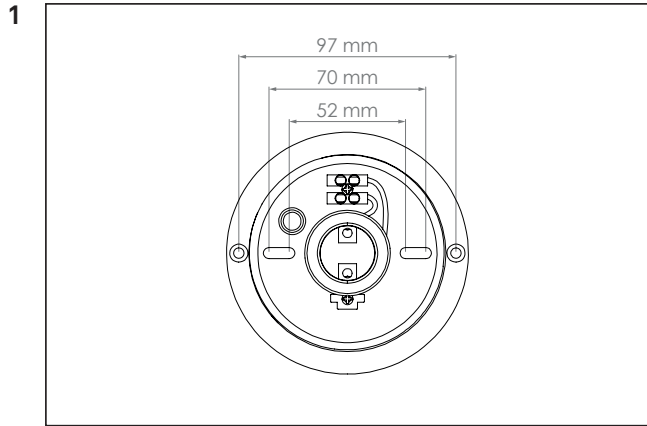

Mounting hole dimensions.

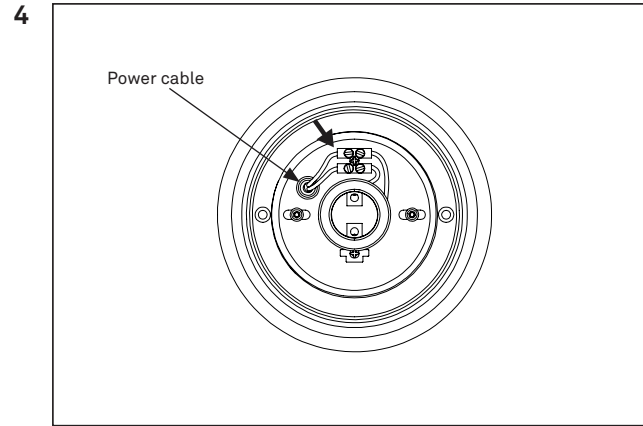

Strip the power cable.
Connect the wire-ends to the cable connector.
Match the brown wire with "L"
the blue wire with "N".

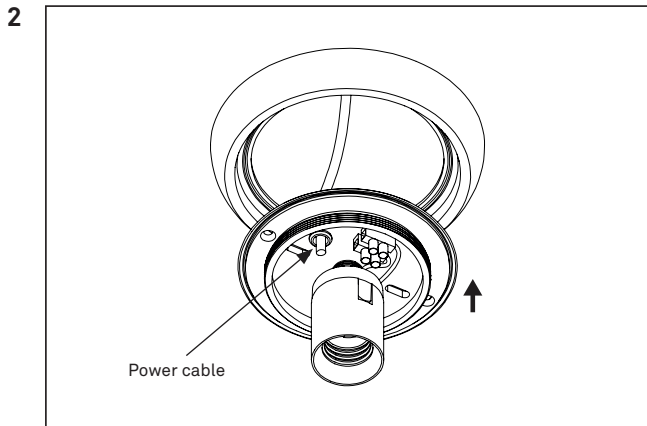

Place bracket over power cable.
Push the power cable through
the rubber plug.
Place lamp base in the bracket
towards the mounting surface.

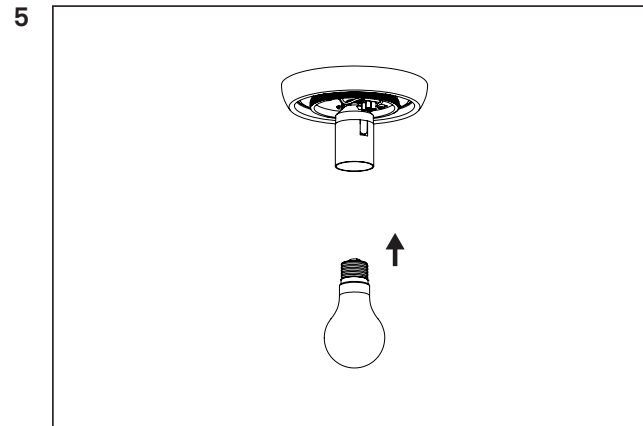

Place a E27 light bulb in
the socket. The bulb is NOT
included.
A recommended light bulb can
be found on www.nuura.com

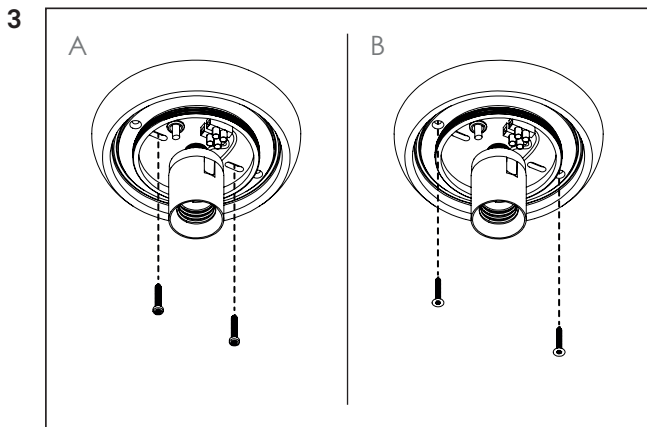

Mount the lamp to the wall or
ceiling by using screw holes A or
screw holes B.
Screw holes A: Aligns with
common junctionboxes.
Screw holes B: Can be used to
mount beside the junctionbox
with lamp insert.
Make sure to use appropriate
rawlplugs/anchors for your
construction.
Please make sure the base is
fixated properly.

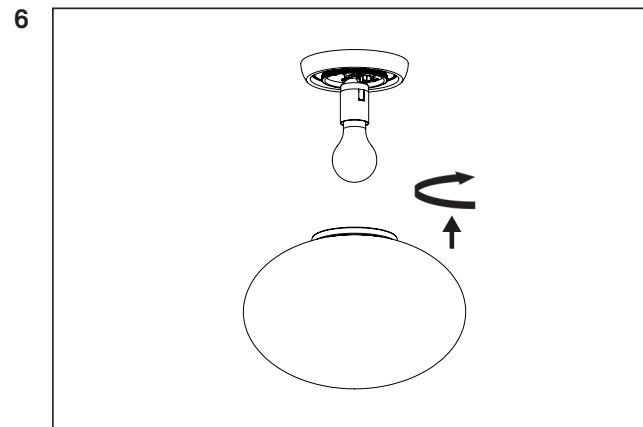

Carefully place the glass over
the light bulb. Turn clockwise to
attach the glass globe.
IMPORTANT: Do NOT over
tighten, the glass may fracture.